

The $\bar{\text{P}}\text{ANDA}$ Barrel-TOF Detector

M. Böhm^{a,*}, K. Götzen^b, L. Gruber^d, N. Kratochwil^d, A. Lehmann^a, H. Orth^b, D. Steinschaden^d, K. Suzuki^d, S. Zimmermann^d

^aFriedrich-Alexander-University of Erlangen-Nuremberg, Erlangen, Germany

^bGSI Helmholtzzentrum für Schwerionenforschung GmbH, Darmstadt, Germany

^cII. Physikalisches Institut, Justus Liebig-University of Giessen, Giessen, Germany

^dStefan Meyer Institute, Vienna, Austria

Abstract

The $\bar{\text{P}}\text{ANDA}$ experiment is a fixed target experiment in which antiprotons collide with stationary hydrogen atoms. The main physics program of the experiment is to study open questions in hadron physics by performing charmonium spectroscopy by precise measurements of width, mass and decay branches and investigating possible exotic states like glueballs and hybrids. The Barrel Time-of-Flight detector (Barrel TOF), which is built in the $\bar{\text{P}}\text{ANDA}$ target spectrometer, located between the DIRC detector and the electromagnetic calorimeter (EMC), has been designed to precisely measure the time at which a charged particle transits the detector with a resolution superior to the other sub-detectors of $\bar{\text{P}}\text{ANDA}$. A time resolution below 100 ps (σ) is mandatory for this sub-detector to fulfill the requirements of good event separation and particle identification below the Cherenkov threshold. The implementation of the Barrel TOF is based on very fast organic scintillator tiles with a size of $87 \times 29.5 \times 5 \text{ mm}^3$ coupled to Silicon Photomultipliers. The total of 1920 tiles are read out each by 8 SiPMs and cover almost the full azimuthal angular range and polar angles from 22.5° to 140° and an area of about 5 m^2 . The current prototypes achieve ~ 60 ps, well below the design goal. The detector R&D is now in a matured stage.

Key words: Scintillation counter, semiconductor detector, time-of-flight, particle identification, photomultiplier

1. Introduction

At the $\bar{\text{P}}\text{ANDA}$ experiment (antiproton annihilation at Darmstadt) at the Facility for Antiproton and Ion Research (FAIR) at GSI in Darmstadt (Germany) cooled antiprotons collide with stationary hydrogen atoms to perform experiments in the charm and strange quark sector with a very high precision[1]. The antiproton beam will have a luminosity up to $2 \cdot 10^{32} \text{ cm}^{-2}\text{s}^{-1}$ and cover a momentum range from 1.5 GeV/c up to 15 GeV/c. The main physics program of the $\bar{\text{P}}\text{ANDA}$ experiment aims to do hadron spectroscopy in the charmonium mass range and to search for exotic hadrons, i.e. hybrids and glueballs. Also hypernuclei, nucleons containing a strange quark, will be measured and the changing properties of hadrons in nuclear matter are studied[2]. The $\bar{\text{P}}\text{ANDA}$ detector will run without a hardware trigger with continuous readout and will have a data rate in the order of 200 GB/s, which needs to

be reduced by a factor of 100. Because of the triggerless architecture, a fast sub-detector with a time resolution below 100 ps to sort events, associate tracks to events and providing time stamps for interactions is required[3, 4, 5, 6]. Since there is no start and stop counter for a time of flight measurement, timestamps from the same event from different tracks are used to calculate the event time (t_0). Furthermore the TOF detector identifies charged low momentum particles that are not detected by the DIRC detector[7] because they are too slow to produce Cherenkov light. Also the TOF provides information for the EMC if a particle has already showered in the radiator bars of the DIRC. Because of the late inclusion of the TOF detector during the design process of $\bar{\text{P}}\text{ANDA}$ it must fit in the 2 cm space between the DIRC and the EMC.

2. The Barrel TOF Detector [8]

The barrel TOF detector is built in 16 independent segments (supermodules) with a size of $2460 \times 180 \text{ mm}^2$

*Corresponding author

Email addresses: merlin.boehm@fau.de (M. Böhm)

covering a polar angle from 22.5° to 140° that are arranged cylindrically around the beam pipe in a distance of around 50 cm around the beam axis. The active area covered with scintillators will be $1800 \times 180 \text{ mm}^2$. On each supermodules 120 scintillating tiles (SciTil) with a size of $87 \times 29.5 \times 5 \text{ mm}^3$ are mounted as illustrated in Fig. 1. The SciTils will probably be made out of EJ-232 material and will be wrapped in aluminised mylar foil. At each short end of the scintillators 4 silicon photomultipliers (SiPM) with an active area of $3 \times 3 \text{ mm}^2$ are glued on and evenly distributed. Two SciTils are glued together with a PCB with SiPMs on both sides, as shown in Fig. 2 (Dual-module). In the current design the supermodules are 16 layer PCBs made out of standard FR4 material that contain the signal wires and provide the bias voltage for the SiPMs as well as mechanical strength. In an attempt to mimic a coaxial structure to minimize the crosstalk between the long parallel signal lanes, ground layers between both the signal layers and ground lanes are used, as showed in Fig. 3. The lanes are placed on the short ends of the SciTils so the PCB material could be cut away under the scintillators to reduce the material budget in the particle paths. On the upstream end of the modules the FEE is mounted. For the FEE using the PETsys TOFPET2 ASIC is in discussion. This chip provides time and charge measurement for 64 individual channels. The charge is measured either by directly integrating or measuring the time over threshold (ToT). Event rates up to 480 kHz can be handled by the ASIC.

To reduce the number of readout channels the 4 SiPMs on the sides of the SciTils are connected together. For this the SiPMs could be connected in parallel, serial or a hybrid of parallel and serial, as shown in Fig. 4. In parallel configuration the required HV is as high as needed for one SiPM but the signal response is slower. In serial configuration the needed HV is 4 times the bias voltage of one SiPM but the signal response is faster due to reduced readout capacity. The hybrid configuration has the advantages of both serial and parallel, the lower needed HV and the faster signal response, but additional electronics must fit on the PCBs for the SiPMs. So this is only a compromise if the FEE cannot handle the higher bias voltage.

3. Measurement results

In the lab surface scans were made using an x-y-stepper and a ^{90}Sr source. A $5 \times 5 \times 5 \text{ mm}^2$ scintillator attached to a SiPM was used as trigger. At each point across the SciTil surface the time differences between the SiPMs on each side and the trigger were measured,

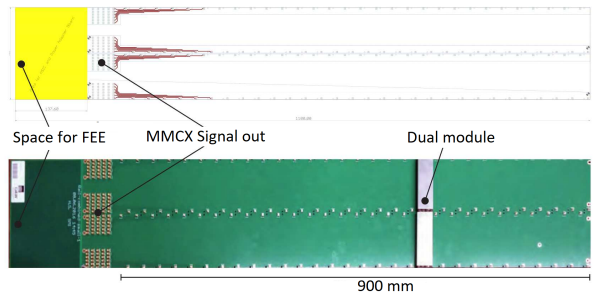
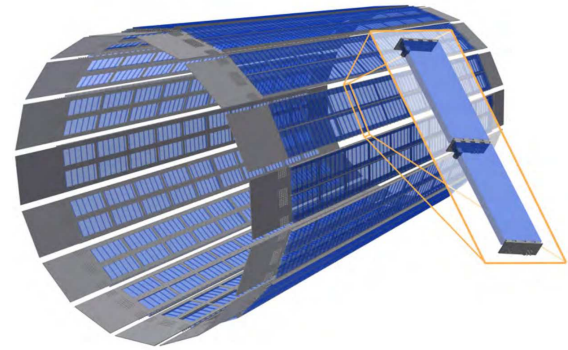

Figure 1: Top: Barrel TOF build with supermodules and pairs of SciTils. Middle: Sketch of the PCB layout of the supermodule. Bottom: Image of a half length prototype of a supermodule with a pair of SciTils mounted.

from which the time resolution can be calculated, as shown in Fig. 5. Additionally the charge was measured, which is a measure of the number of counted photons. With this measurement setup several configurations were studied and 2D plots were created to estimate the time resolution along the scintillator surface, as seen in Fig. 6. It turned out that 4 SiPMs per side were necessary to achieve a good time resolution along the whole surface area. A size of around $90 \times 30 \times 5 \text{ mm}^3$ showed to be a good compromise between size (and required readout channels) and time resolution. Also the scintillator was wrapped with different materials which showed that reflective material scatters photons that would leave the scintillator are being reflected back and can reach the SiPMs. For the wrapping material aluminised mylar foil proved to be the best material. But this seems only to apply to directly reflected photons, not to diffusely reflected photons, because when wrapping the scintillator with teflon tape the time resolution gets worse as shown in Table 1.

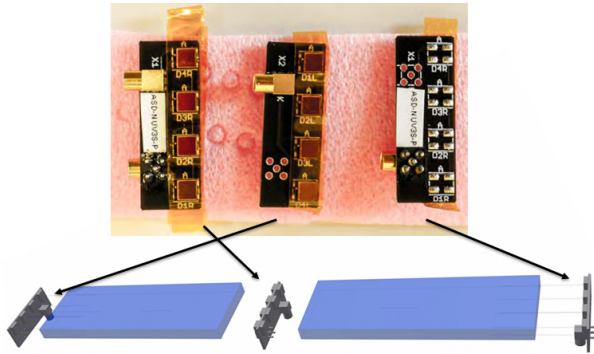

Figure 2: Image and illustration of the connection of two SciTils (Dual-Module).

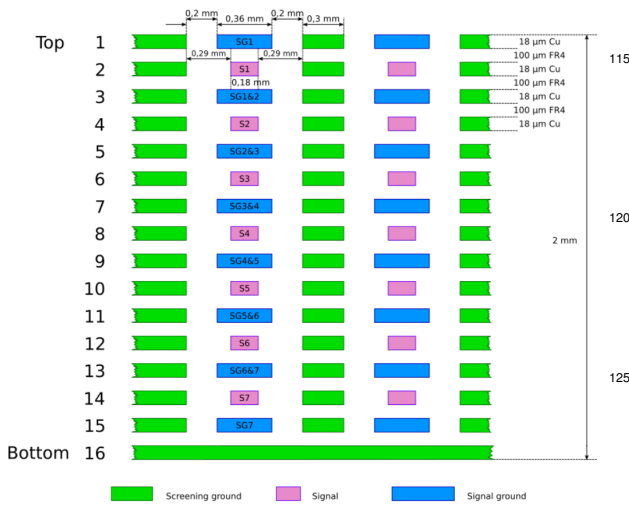

Figure 3: Crosssection of the signal lanes of the planned Supermodule PCB.

Wrapping material	Time resolution [ps]
No wrapping	55.0 ± 0.3
Aluminised Mylar foil	52.7 ± 0.3
Aluminium foil	54.2 ± 0.3
Tyvek herdstructure 1057D	55.0 ± 0.3
Enhanced specular reflector	55.2 ± 0.3
Teflon tape	59.4 ± 0.3

Table 1: Comparison between different wrapping materials and achieved time resolution.

Further lab tests indicated that time resolution could be improved by approx. 5-10 ps compared to an unwrapped SciTil. Using a $90 \times 30 \times 5 \text{ mm}^3$ SciTil wrapped in aluminised mylar foil an average time resolution of 54 ps was reached. These results were verified at two CERN beam times in 2015 and 2016 where us-

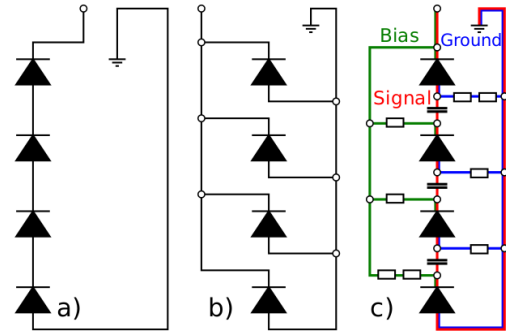

Figure 4: Schematics of different SiPM connections, a) serial, b) parallel, c) hybrid.

ing $50 \times 30 \times 5 \text{ mm}^3$ SciTils made out of BC-418 and wrapped in aluminised mylar foil, a single counter time resolution of ~ 50 -70 ps was reached. Even with a $120 \times 5 \times 5 \text{ mm}^3$ BC-420 an average time resolution of < 80 ps has been reached[9]. With these time resolutions it is possible to get a rudimentary position reconstruction along the long axis of the SciTil in the order of ~ 1 cm. A side effect of using longer SciTils (> 5 cm on the long edge) is that the time resolution gets worse in the middle of the SciTil and remains good in front of the SiPMs. The reason is that on one side less photons from the center of the SciTil reach the SiPMs and on the other side the flight path variation of the photons is larger than at the end of the SciTil.

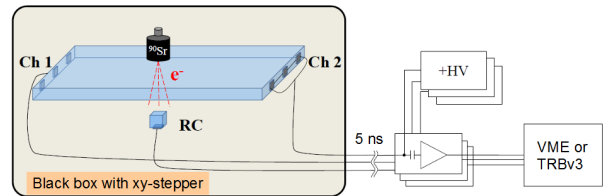

Figure 5: Measurement setup for the SciTils. [10]

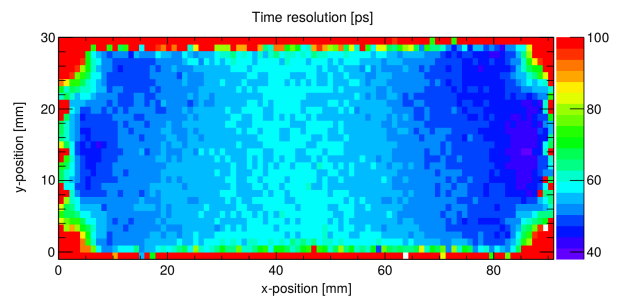

Figure 6: Time resolution distribution along the surface of a $90 \times 30 \times 5 \text{ mm}^3$ EJ-232 scintillator. The average was ~ 54 ps.

4. Conclusion

130 For the PANDA experiment the barrel TOF detector
is an important component for low momentum charged
particle identification and track reconstruction. In order
to fulfill the requirements lab measurements and beam
times showed that the required time resolution below
100 ps has well been reached. For the FEE research and
135 development is still ongoing.

Acknowledgments

This work is supported by the German BMBF and
GSI Darmstadt.

References

- 140 [1] PANDA Collaboration, Technical Progress Report, FAIR-
ESAC/Pbar 2005.
- [2] PANDA Collaboration, Physics Performance Report 2009.
[arXiv:0903.3905v1](https://arxiv.org/abs/0903.3905v1).
- 145 [3] Akindinov, A. et al, Performance of the ALICE Time-Of-Flight
detector at the LHC, The European Physical Journal Plus 128 (4)
(2013) 44. doi:10.1140/epjp/i2013-13044-x.
URL <https://doi.org/10.1140/epjp/i2013-13044-x>
- [4] Adam, J. et al, Determination of the event collision time
with the ALICE detector at the LHC, The European Physical
150 Journal Plus 132 (2) (2017) 99. doi:10.1140/epjp/
i2017-11279-1.
URL <https://doi.org/10.1140/epjp/i2017-11279-1>
- [5] Basile, M et al, A large-area time-of-flight system for
a colliding beam machine, Nuclear Instruments and
155 Methods 179 (3) (1981) 477 – 485. doi:[https://doi.org/10.1016/0029-554X\(81\)90171-3](https://doi.org/10.1016/0029-554X(81)90171-3).
URL [http://www.sciencedirect.com/science/
article/pii/0029554X81901713](http://www.sciencedirect.com/science/article/pii/0029554X81901713)
- [6] A. Sanchez-Lorente, L. Schmitt, C. Schmitt, K. Goetzen, A.
160 Kisselev, Motivation of the barrel time-of-flight detector for
PANDA, PANDA Note.
- [7] P. Coyle, et al., The dirc counter: a new type of particle identi-
fication device for b factories, Nucl. Instr. and Meth. A 343 (1)
(1994) 292 – 299. doi:10.1016/0168-9002(94)90568-1.
- 165 [8] PANDA Collaboration, Technical Design Report for the
PANDA Barrel Time-of-Flight.
- [9] M. Böhm and A. Lehmann and S. Motz and F. Uhlig, Fast SiPM
Readout of the PANDA TOF Detector, Journal of Instrumenta-
tion 11 (05) (2016) C05018.
170 URL [http://stacks.iop.org/1748-0221/11/i=05/a=
C05018](http://stacks.iop.org/1748-0221/11/i=05/a=C05018)
- [10] P. W. Cattaneo, M. D. Gerone, F. Gatti, M. Nishimura,
W. Ootani, M. Rossella, Y. Uchiyama, Development of high
175 precision timing counter based on plastic scintillator with
sipm readout [arXiv:arXiv:1402.1404](https://arxiv.org/abs/1402.1404), doi:10.1109/TNS.
2014.2347576.